

**Article Info**

Received: 02 Mar 2014 | Revised Submission: 10 Mar 2014 | Accepted: 30 May 2014 | Available Online: 15 Jun 2014

---

**Thermodynamic Analysis of Alternative Regeneration Gas Turbine Cycle with Twin Shaft System**

*P. V. Ram Kumar\* and S. S. Kachhwaha\*\**

---

**ABSTRACT**

*The study describes the thermodynamic methodology for the performance evaluation of alternative regeneration gas turbine cycle with twin shaft system. The effects of pressure ratio, turbine inlet temperature, inlet air temperature and regenerative effectiveness used in the thermodynamic analysis of alternative regeneration gas turbine cycle with twin shaft system on thermal efficiency, specific work output and specific fuel consumption of the cycle have been investigated. It is observed that thermal efficiency of gas turbine alternate regeneration system increases with pressure ratio with increase in turbine inlet temperature and specific work output increases with increase in turbine inlet temperature but lower than conventional regeneration system. The thermal efficiency and specific work output of the cycle increases with decrease in inlet air temperature. The specific fuel consumption decreases with increase in both pressure ratio and turbine inlet temperature and with decrease in inlet air temperature. This system is very attractive at high turbine inlet temperature of 1500 OC and above.*

**Keywords:** *Gas Turbine System; Alternative Regeneration; Energy Analysis; Effectiveness.*

---

**1.0 Introduction**

The demand of energy in the developing world has witnessed pronounced increase in the recent past. Much of the growth in new electricity demand is expected to come from countries of the developing world. Therefore it is important to find improved technologies for power generation that have high efficiency and specific work output, low investment, low operating and maintenance cost and low emissions of pollutants. Industrial gas turbines are one of the well established technologies for power generation. The gas turbine applications have been expanded appreciably due to significant improvements in cycle efficiency in the recent years. This has made gas turbines competitive alternatives to diesel engines and rankine steam cycles. The advantage of gas turbines lies in the fact that they have high power/weight ratio compared to reciprocating engines. The power generation market is becoming increasingly dynamic and competitive with deregulation in power generation industry

worldwide. In recent years the observed performance enhancements in the gas turbine technologies can be attributed to the advancements in the fields of aerodynamics, materials and coatings, blade cooling and fabrication technologies. These technologies have allowed achieving the turbine inlet temperature value of 1500 OC and simple cycle efficiencies of 40 % and above.

An alternative approach to improve the gas turbine cycle efficiency is to modify the brayton cycle by adopting intercooled compression or reheat expansion or regeneration or the combinations of these modifications. In a simple gas turbine (GT) system, high pressure ratio is required to obtain high thermal efficiency due to the absence of a heat exchanger.

The application of regenerator or heat exchanger has caused significant impact on the gas turbine cycle to obtain higher efficiency at low pressure ratios by utilising the waste heat carried by the exhaust gases. This waste heat is utilised to preheat the air between compressor and combustion

---

\*Corresponding Author: Department of Mechanical Engineering, Delhi College of Engineering, Delhi, India  
(E-mail: pvrde@rediffmail.com)

\*\*Department of Mechanical Engineering, PDP University, Gandhi Nagar, Gujarat, India

chamber. In this way the average temperature of air at which heat is added during combustion is increased resulting in higher cycle efficiency. Ganesan [1], Cohen et al. [2], Cengel [3] and Nag [4] have suggested the different cycle arrangements to improve efficiency and net work output of the system. Nishida et al. [5] studied the regenerative steam injection gas turbine systems (RSTIG) and the performances of these systems were compared with those of simple, regenerative and STIG systems based on exergy analysis and showed an improved efficiency & specific work output compared with simple and regenerative cycle. Caniere et al. [6] observed increase in the cycle efficiency by intercooling in air cooled Gas Turbines. De Lucia et al. [7] studied gas turbines with inlet evaporative and absorption air-cooling and reported that application of these cooling methods enhances the power output and thermal efficiency. Khaliq et al. [8] studied the thermodynamic performance evaluation of combustion gas turbine co-generation system with reheat and presented a methodology based on first and second law of thermodynamic analysis.

Najjar [9,10] studied the enhancement of performance of gas turbine engines by inlet air cooling and co-generation system and reported the improvement in power output, efficiency and specific fuel consumption (SFC) in the combined system over simple gas turbine cycles and thermo economic evaluation showed that the combined system is viable. Kakaras et al. [11,12] studied the compressor intake air cooling using the absorption cooling and evaporative cooling in gas turbine plants for a simple gas turbine and a combined cycle plant. The inlet air cooling methods for gas turbine based power plants have been studied and reported that the highest incremental electricity generation is realized by absorption intake air cooling. Dellenbeck [13] reported that the cycle efficiency of alternative configuration is superior to either a conventional regenerative cycle or a simple cycle.

The alternative regeneration system is particularly attractive at high turbine inlet temperatures. For turbine inlet temperatures as high as 1500 °C the optimum pressure ratio is only 30 whereas for the same conditions the optimum pressure ratio of a simple cycle is excessive (>40) for temperatures larger than 1115 °C. Dellenbeck [13] had explained that the location of regenerator after

the power turbine is inefficient and suggested that the location of regenerator between two turbines (alternative regenerator configuration) improves the cycle efficiency. Hwang et al. [14] studied the design and off-design characteristics of the Alternative Recuperated Gas Turbine Cycle with divided turbine expansion and their study included the fundamental characteristics, various design options and part load analysis of the cycle and its comparison with conventional cycle. According to this study [14], the alternative cycle is more influenced by the component efficiencies.

Only with very high component efficiencies, the maximum cycle efficiency of the alternative cycle is higher than that of the conventional cycle. Two shaft design of the alternative cycle requires very high compressor pressure ratio for its efficiency to be comparable with the conventional cycle. On the contrary the single shaft design provides a rather wide range of compressor design pressure ratio. By designing with single shaft configuration and operating with variable shaft speed, the alternative cycle provides far better part load efficiency than conventional cycle.

As the location of alternative regenerator between two stages of turbine is a recently introduced concept, it is felt that a detailed thermodynamic energy analysis is to be studied with detailed parametric analysis for wide range of design parameters.

It is observed from the literature survey that alternative regenerator system with two shaft configuration has not been comparatively analysed with conventional gas turbine regenerative cycle. Hence the present study describes the detailed first law energy analysis of alternative regenerator system with two shaft configuration in comparison to simple and conventional regenerative cycles.

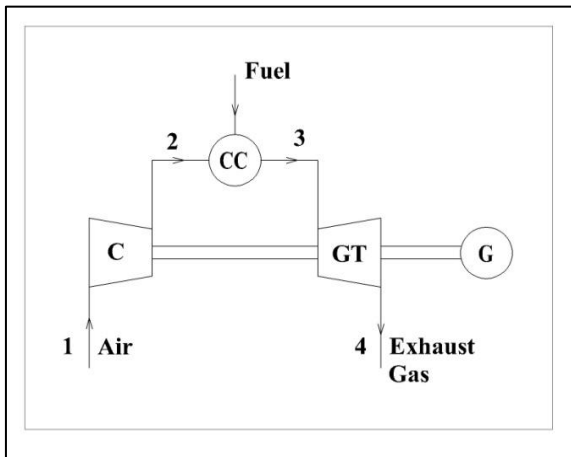
## 2.0 System Description

The plant configurations of simple gas turbine system and conventional regeneration gas turbine system are shown in Fig. 1 and Fig. 2 respectively.

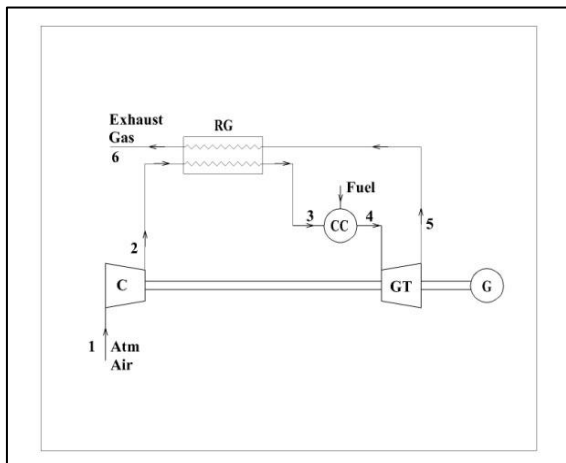
The alternate regeneration GT cycle with twin shaft system configuration is shown in Fig. 3, which consists of compressor, high pressure turbine, combustion chamber, power turbine and alternative

regenerator which is proposed for thermodynamic analysis. The atmospheric air is compressed in the compressor and then it enters into alternate regenerator where it is heated by the exhaust gases from high pressure turbine. The preheated air enters into combustion chamber where heat is added to achieve maximum permissible temperature. The hot gases expand and develop the power in the high pressure turbine such that the total work output of this turbine is utilised to run the compressor. The gases coming out from the high pressure turbine pass through alternate regenerator where it exchanges heat to preheat the air and finally expand in power turbine. The power developed by the power turbine is the net work output of the system.

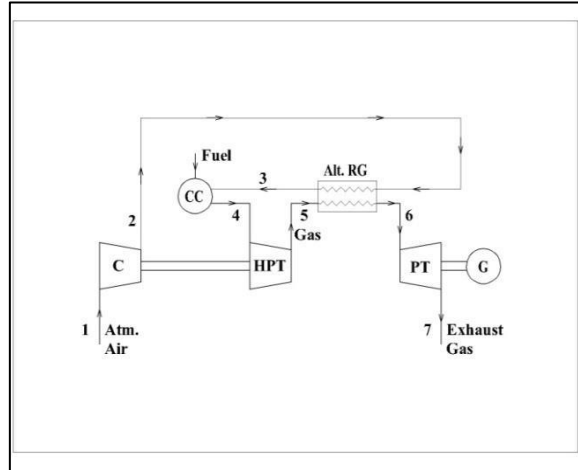
**Fig 1: Schematic Diagram of Simple Gas Turbine Cycle**



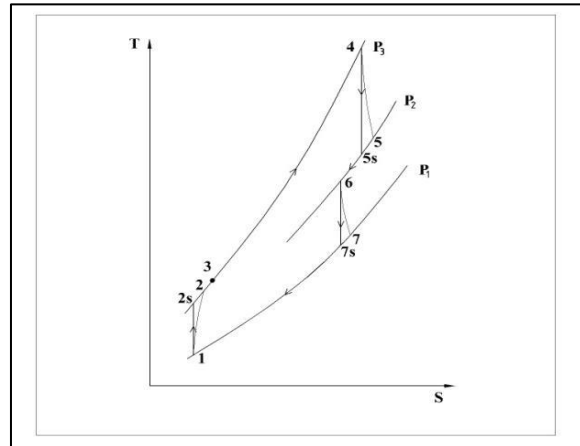
**Fig 2: Schematic Diagram of Gas Turbine Regenerative Cycle**



**Fig 3: Schematic Diagram of Gas Turbine with Alternative Regeneration Cycle**



**Fig 4: Schematic Diagram of T-s Diagram of Alternate Regeneration Cycle**



### 3.0 Thermodynamic Analysis

Thermodynamic formulations for simple gas turbine cycle (Fig. 1), gas turbine cycle with regeneration (Fig. 2) and gas turbine cycle with alternative regenerator (Fig. 3) has been developed and compared for similar input conditions. Fig. 4 represents the corresponding T-s diagram of the alternate regeneration system configuration. For the conventional regeneration the single shaft configuration is considered whereas for the alternate regeneration two shaft configuration is adopted. The air at atmospheric conditions ( $T_1, p_1$ ) enters into the compressor.

The exit pressure after compression is  $p_2$ .

The pressure ratio of the compressor is

$$r = \frac{p_2}{p_1} \quad (1)$$

The temperature ratio for ideal compression process in the compressor and compressor efficiency is given by

$$\frac{T_{2s}}{T_1} = (r)^{\left(\frac{\gamma-1}{\gamma}\right)}_a \quad (2)$$

$$\eta_c = \frac{T_{2s} - T_1}{T_2 - T_1} \quad (3)$$

The effectiveness of regenerator is defined as

$$E = \frac{T_3 - T_2}{T_5 - T_2} \quad (4)$$

where  $T_3$  and  $T_5$  are temperature of air leaving the regenerator and outlet temperature of gas from high pressure turbine (HPT) entering the regenerator respectively.

As per the assumed condition, the high pressure turbine (HPT) is only meant for running the compressor, therefore

$$W_c = W_{HPT} \quad (5)$$

The inlet temperature of hot gases at HPT inlet is  $T_4$ . After expansion, the exit temperature is given by  $T_5$ . The temperature ratio for ideal expansion process and efficiency of HPT are given by

$$\frac{T_4}{T_{5s}} = (r_{HPT})^{\left(\frac{\gamma-1}{\gamma}\right)}_g \quad (6)$$

$$\eta_{HPT} = \frac{T_4 - T_5}{T_4 - T_{5s}} \quad (7)$$

Where  $r_{HPT}$  is the pressure ratio in HPT.

The temperature of air leaving the regenerator is calculated using equation (4).

$$T_3 = T_2 + E (T_5 - T_2) \quad (8)$$

The heat balance equation in combustion chamber is represented as

$$Q_s = f(CV) \eta_{cc} = (1+f) C_{pg}(T_4 - T_3) \quad (9)$$

Where  $Q_s$  the heat supplied,  $f$  is fuel flow rate per kg air flow rate,  $\eta_{cc}$  is combustion efficiency of combustion chamber and  $CV$  is calorific value of fuel.

The heat balance equation in the regenerator is given by

$$C_{pa}(T_3 - T_2) = (1+f) C_{pg}(T_5 - T_6) \quad (10)$$

The temperature ratio for ideal expansion process in power turbine (PT) and efficiency of PT ( $\eta_{PT}$ ) are given by

$$\frac{T_6}{T_{7s}} = (r_{PT})^{\left(\frac{\gamma-1}{\gamma}\right)}_g \quad (11)$$

$$\eta_{PT} = \frac{T_6 - T_7}{T_6 - T_{7s}} \quad (12)$$

The specific work output from the power turbine is given by

$$W_{PT} = (1+f) C_{pg}(T_6 - T_7) \quad (13)$$

Where  $T_7$  is the temperature of gas leaving the power turbine.

The thermal efficiency of the cycle is

$$\eta_{cycle} = \frac{W_{PT}}{Q_s} \quad (14)$$

The specific fuel consumption is

$$sfc = \frac{f \times 3600}{W_{PT}} \quad (15)$$

The ambient conditions considered in the present calculations are 101.3 kPa and 300 K. The pressure loss in combustion chamber and regenerator are assumed to be 3 % and 2 % respectively. The specific heat for constant pressure ( $C_p$ ) for gases and air are assumed as 1.147 kJ/kg/K and 1.005 kJ/kg/K and  $\gamma$  for gases and air are assumed as 1.33 and 1.4 respectively. Compressor and turbine efficiencies are assumed as 86 % and 89 % respectively. The combustor efficiency is assumed to be 99 %.

The important operating parameters for thermodynamic performance analysis are pressure ratio ( $r$ ), turbine inlet temperature (TIT), inlet air temperature ( $T_1$ ) and the effectiveness of regenerator ( $E$ ). The effect of variation of these parameters on cycle efficiency, specific work output and specific fuel consumption has been studied in detail. The range for the variation of these parameters is discussed below.

#### 4.0 Results and Discussions

The thermodynamic performance of the gas turbine alternative regeneration system is analysed and compared with conventional regeneration and simple gas turbine cycles for wide range of design parameters. The effect of variation of pressure ratio, TIT, inlet air temperature (IAT) and regenerator effectiveness on cycle efficiency, specific work output and specific fuel consumption has been studied in detail.

The pressure ratio is varied between 0 and 40. The values selected for TITs are 1100 OC and 1500 OC. The effectiveness of regenerator is varied between 0.6 and 0.8. These values are approachable in the recently developed components of gas turbine cycles.

**4.1 Effect of pressure ratio**

**4.1.1 Effect of pressure ratio on cycle efficiency**

The comparison for the variation of cycle efficiency with pressure ratio for alternative regeneration, conventional regeneration and simple cycle is shown in Fig. 5. For alternative and conventional regeneration configurations the cycle efficiency increases sharply up to an optimum pressure ratio and afterwards cycle efficiency starts decreasing with increase in pressure ratio for a typical TIT value. The cycle efficiency increases with increase in TIT for a given pressure ratio. Further the optimum pressure ratio corresponding to maximum cycle efficiency increases with TIT. For the same TIT value and other input conditions, the optimum pressure ratio is higher for alternative regeneration as compared to conventional regeneration system. Table 1 illustrates the optimum pressure ratio and the corresponding cycle efficiency for both alternative and conventional regeneration systems. For example at TIT = 1500 O C , the maximum cycle efficiency of alternative regeneration system is 55.02 % corresponding to optimum pressure ratio 22.5, whereas the maximum efficiency for conventional regeneration configuration is 51.31 % corresponding to optimum pressure ratio 8.5. Thus there is net increase of 3.71 % in cycle efficiency.

For a prescribed TIT and the pressure ratio greater than optimum value, the rate of reduction in cycle efficiency with respect to pressure ratio is relatively low in alternative regeneration system as compared to conventional regeneration system. Therefore the deviation of pressure ratio near the optimum value causes relatively less reduction in cycle efficiency for alternative regeneration system. The efficiency for alternative regeneration system is above 50 % for variation of pressure ratio from 10 and above.

The efficiency of alternative regeneration system increases with increase in turbine inlet

temperature (TIT) and is promising particularly at higher TITs of 1500 OC and above and also at higher corresponding pressure ratios. At lower pressure ratios conventional regeneration has relatively higher efficiency due to lower temperature of compressed air and lower efficiency at higher pressure ratios because at higher pressure ratio most of the power developed is utilised to run the compressor. The efficiency of simple cycle continuously increases with increase in pressure ratio and TIT.

**Table 1: Optimum Pressure Ratio and the Corresponding Cycle Efficiency**

TIT (°C)	$r_p$		$\eta$	
	Alternative Regeneratio n	Conventiona l Regeneratio n	Alternative Regeneratio n	Conventiona l Regeneratio n
1100	12	6	45.58 %	43.94 %
1500	22.5	8.5	55.02 %	51.31 %

Figure 6 shows the effect of variation of pressure ratio on cycle efficiency for different values of regenerator effectiveness for TIT of 1500 OC. For alternative regeneration system, cycle efficiency increases with effectiveness for wide range of pressure ratios. The values of optimum pressure ratios are 22.5, 29 and 35 corresponding to their respective effectiveness of curves. For conventional regeneration system, cycle efficiency increases with effectiveness. The optimum pressure ratios in this case are 8.5, 12 and 15.5 corresponding to their respective effectiveness curves.

The cycle efficiency corresponding to optimum pressure ratios for conventional regeneration system is more sensitive to alternative regeneration cycle. For pressure ratios lower than the optimum values of conventional regeneration cycle, the efficiency of conventional regeneration cycle is higher and vice versa for higher values of pressure ratios.

It is evident from Fig. 6 that cycle efficiency is a strong function of effectiveness for pressure ratios nearer to the optimum values. Since the regenerator is absent in the simple cycle, the efficiency increases continuously with pressure ratio.

#### 4.1.2 Effect of pressure ratio on specific work output

The effect of pressure ratio ( $r$ ) on specific work output is shown Fig. 7. It has been observed that the specific work output of alternative regeneration system increases with pressure ratio for the given TIT as shown in Fig. 7 whereas for conventional and simple cycles specific work output initially increases with pressure ratio and after reaching a maximum it starts decreasing with further increase in pressure ratio. The specific work output of alternative regeneration system increases with increase in TIT and the impact is quite significant for high pressure ratios. The specific work output of alternative regeneration system is lower as compared to conventional regeneration system and simple cycle because the complete expansion of gases from TIT to exhaust temperature is taking place in the gas turbine of the conventional regeneration system whereas in the alternative regeneration system the gas coming out from high pressure turbine (HPT) is first partially cooled to preheat the air coming from compressor and then enters into power turbine which develops useful work output. The low specific work output of alternative regeneration system can be compensated by increasing the TIT and pressure ratio.

The specific work output of alternative regeneration system is increased by 67.15 % by increasing the TIT from 1100 0C to 1500 0C for the corresponding optimum pressure ratios of maximum cycle efficiency whereas the specific work output of conventional regeneration system is increased by 41.83 % for the same conditions. In overall, the effect of increase of TIT on specific work output is relatively higher for alternative regeneration cycle.

As shown in Fig. 8, the increase in effectiveness of regenerator decreases the specific work output of the alternative regeneration system whereas the specific work output of the conventional regeneration system is same irrespective of effectiveness of regenerator but higher than the alternate regeneration system because in the conventional regeneration system the heat of exhaust gas coming out from gas turbine is utilised to preheat the air in the regenerator. The specific work output of alternative regeneration system is increased by 14.75 % by decreasing the effectiveness from 0.8 to 0.6 for the corresponding optimum pressure ratios of maximum cycle efficiency.

#### 4.1.3 Effect of pressure ratio on specific fuel consumption

The effect of pressure ratio on specific fuel consumption (sfc) is shown Fig. 9 for different values of TITs. It is observed that specific fuel consumption (sfc) of alternative regeneration system and conventional regeneration system decreases with pressure ratio upto the optimum value and increases afterward's for a given turbine inlet temperature (TIT). For simple cycle the sfc continuously decreases with pressure ratio. The sfc is higher for conventional regeneration system than the alternative regeneration system for the pressure ratio of 9 and above. The specific fuel consumption of alternative regeneration system is decreased by 17.14 % by increasing the TIT from 1100 0C to 1500 0C for the corresponding optimum pressure ratios of maximum cycle efficiency.

The variation of sfc for conventional regeneration system is highly sensitive as compared to alternative regeneration system for higher pressure ratios. As shown in Fig. 10, sfc for alternative regeneration system increases with decrease in regenerator effectiveness for wide range of pressure ratios and sfc is lower for the alternative regeneration system than the conventional regeneration system at higher pressure ratios because of higher cycle efficiency.

The increase in effectiveness of regenerator increases the cycle efficiency and hence reduction in the sfc. Even the sfc of simple cycle at pressure ratio of 40 is not able to achieve the corresponding sfc of alternative regeneration system. The specific fuel consumption of alternative regeneration system is increased by 6.88 % by decreasing the effectiveness from 0.8 to 0.6 for the corresponding optimum pressure ratios of maximum cycle efficiency.

#### 4.2 Effect of turbine inlet temperature (TIT) on performance parameters

Effect of turbine inlet temperature (TIT) on the cycle efficiency, specific work output and specific fuel consumption is studied and compared for alternative regeneration, conventional regeneration and simple cycle configurations corresponding to optimum pressure ratios. the effect of TIT on thermal efficiency of the cycle is studied and compared with conventional regeneration and simple cycle at the corresponding optimum pressure ratios for the



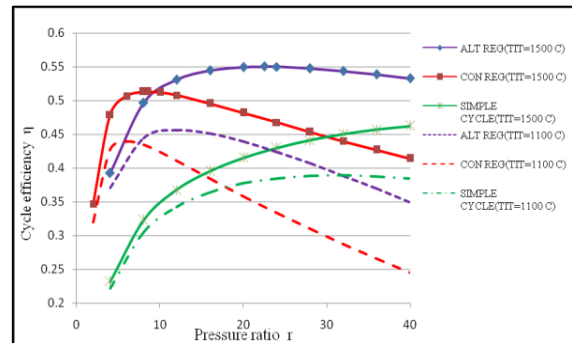
maximum cycle efficiencies as shown in Fig. 11. For TIT equal to 1200 0C and above, the alternative regeneration cycle efficiency is higher as compared to conventional regeneration system. The cycle efficiency for simple cycle is lowest for wide range of TITs. Therefore the alternative regeneration system is suitable for relatively higher TITs. The efficiency of alternative regeneration system is higher by 7.23% and 19.01% as compared to conventional regeneration system and simple cycle respectively for the value of TIT of 1500 0C. The specific work output increases with TIT for all the cases as shown in Fig. 12. It has been further observed that the specific work output of alternative regeneration system is always lower than conventional regeneration system with increase in TIT for the corresponding optimum pressure ratios mentioned above. At higher TITs there is increase in the specific work output of conventional regeneration system as compared to the alternative regeneration system. The specific work output of alternate regeneration system is lower by 21.69% with conventional regeneration system at a TIT of 1500 0C. Though the slope for specific work output for simple cycle is highest, specific work output for simple cycle is lowest below TIT of 1300 0C. It is observed that the specific fuel consumption (sfc) decreases with increase in TITs for all the three configurations for the corresponding optimum pressure ratios as shown in Fig. 13. It shows that the alternative regeneration system is attractive at higher TITs as sfc is lower than the conventional regeneration system and simple cycle configurations.

**4.3 Effect of inlet air temperature (IAT) on performance parameters**

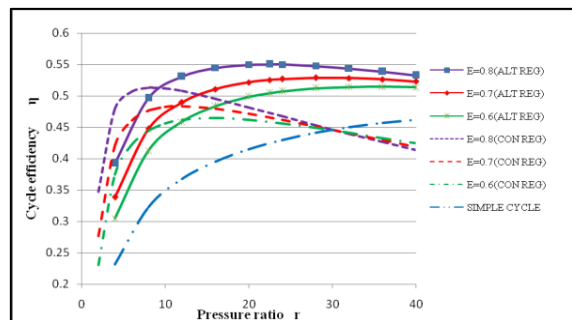
Effect of inlet air temperature (T1) on the cycle efficiency, specific work output and specific fuel consumption is studied and compared for alternative regeneration, conventional regeneration and simple cycle configurations corresponding to optimum pressure ratios and TIT equal to 1500 0C. The effect of inlet temperature (IAT) on cycle efficiency is shown in Fig. 14. It has been observed that decrease in inlet air temperature increases the cycle efficiency for all three cases. At the regenerator effectiveness equal to 0.8, for every 10 K temperature drop the cycle efficiency rise is 2.11 % for alternative regeneration and 1.69 % for conventional regeneration systems respectively. For simple cycle

efficiency increases by 1.15 % for every 10 K reduction of inlet air temperature (IAT). Thus alternative regeneration system is relatively efficient at lower IAT and higher regenerator effectiveness as compared to conventional system. The effect of inlet temperature (IAT) on specific work output is shown in Fig. 15. The specific work output increases with decrease in IAT. The specific work output for conventional regeneration is higher as compared to alternative regeneration system. The average increase of specific work output for 10 K temperature drop of IAT is 0.903 % for alternative regeneration, 2.21 % for conventional regeneration and 5.2 % for simple cycle configurations respectively. Thus the effect of IAT on specific work output is least in the case of alternative regeneration system and specific work output of simple cycle is most sensitive to IAT. It is observed that the specific fuel consumption (sfc) increases linearly with increase in IAT for all the cases as shown in Fig. 16. For every 10 K rise in IAT, sfc increases by 2.104 % for alternative regeneration, 1.69 % for conventional regeneration and 2.1.15% for simple cycle configurations respectively.

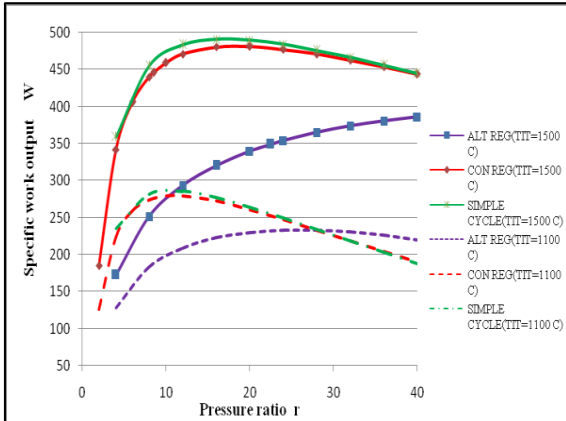
**Fig: 5. Effect of Pressure Ratio on Cycle Efficiency with TIT [T1=300 K, E=0.8]**



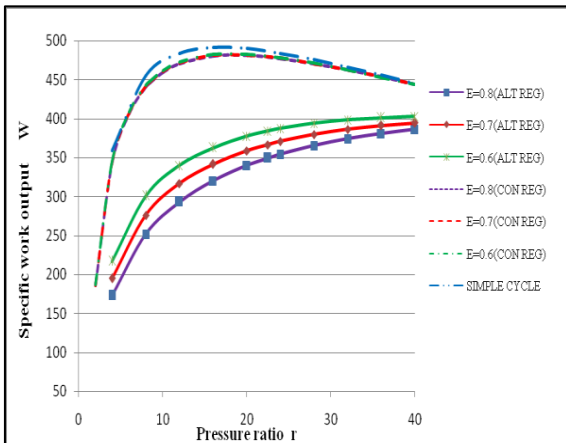
**Fig: 6. Effect of Pressure Ratio on Efficiency with Effectiveness [T1=300 K, TIT=1500 0C]**



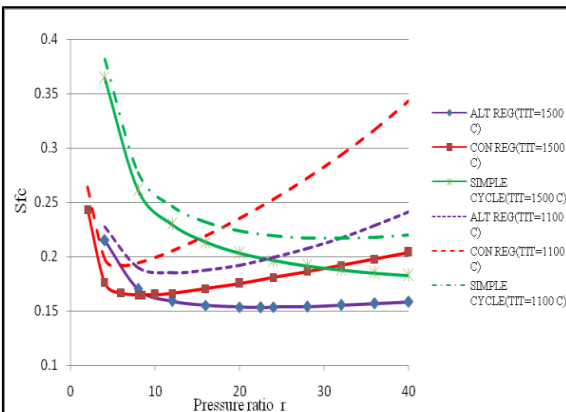
**Fig 7: Effect of Pressure Ratio on Specific Work Output with TITs [T1=300 K, E=0.8]**



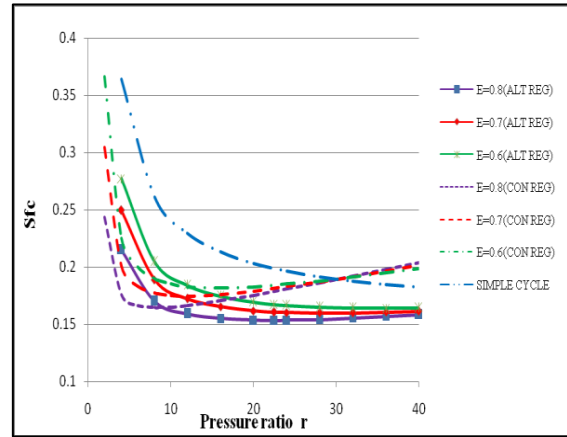
**Fig 8: Effect of Pressure Ratio on Specific Work Output with Effectiveness [T1=300 K, TIT=1500 0C]**



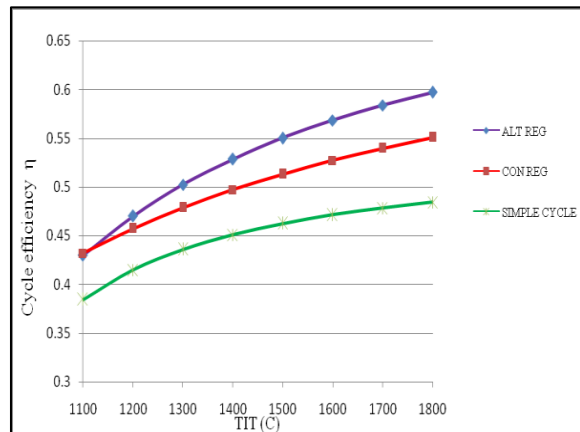
**Fig 9: Effect of Pressure Ratio on Specific Fuel Consumption with TIT [T1=300 K, E=0.8]**



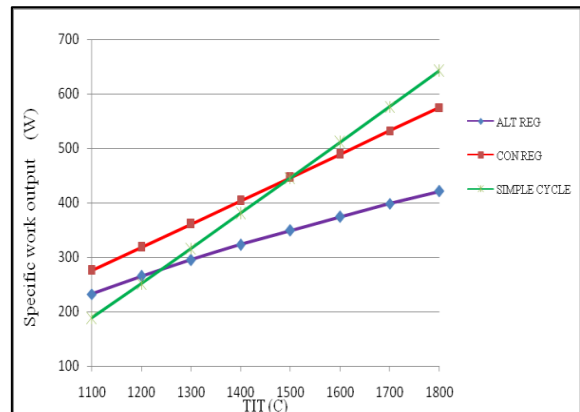
**Fig 10: Effect of Pressure Ratio on Specific Fuel Consumption with Effectiveness [T1=300 K, TIT=1500 0C]**



**Fig 11: Effect of TIT on Efficiency [T1=300 K, r = ropt]**

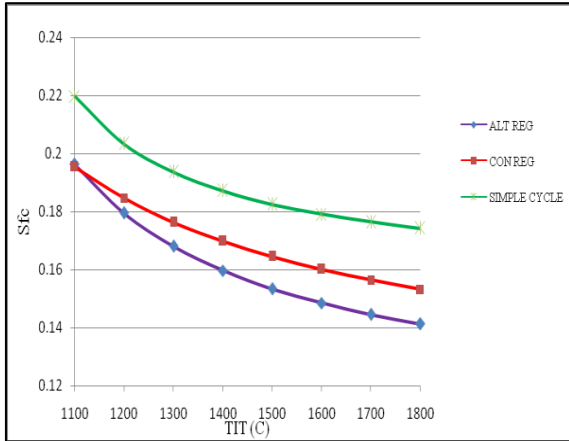


**Fig 12: Effect of TIT on Specific Work Output [T1=300 K, r = ropt]**

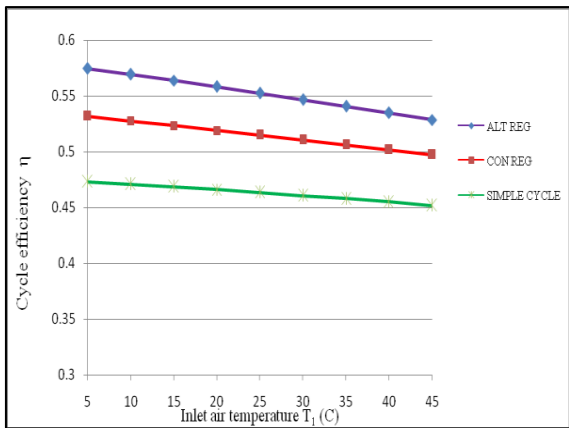




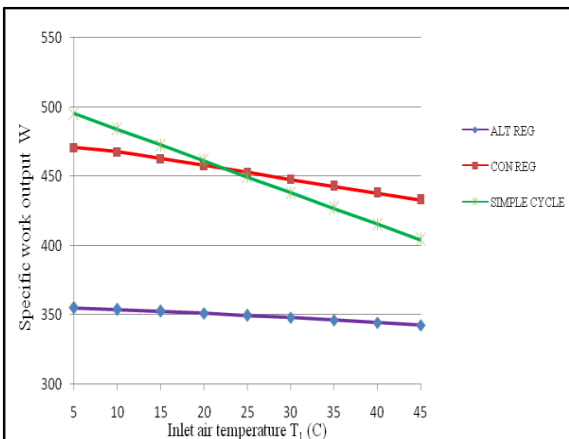
**Fig 13: Effect of TIT on Specific Fuel Consumption [T1=300 K, r = ropt]**



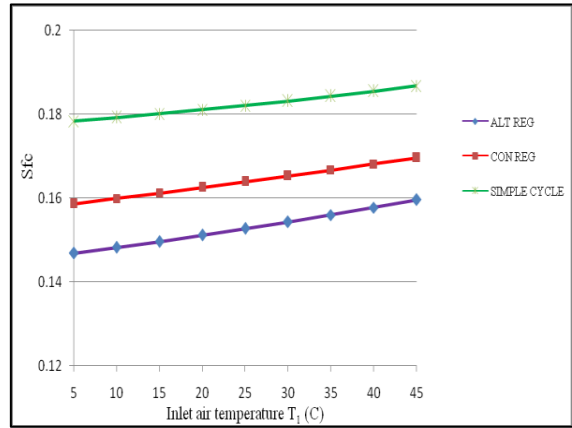
**Fig 14: Effect of the Inlet Air Temperature on Efficiency [TIT = 1500 0C, r = ropt]**



**Fig 15: Effect of the Inlet Air Temperature on Specific Work Output [TIT = 1500 0C, r = ropt]**



**Fig 16: Effect of the Inlet Air Temperature on Specific Fuel Consumption [TIT = 1500 0C, r = ropt]**



**5.0 Conclusion**

The thermodynamic performance analysis of three cases of gas turbine systems has been studied in this paper: alternative regeneration gas turbine cycle with twin shaft system, conventional regeneration cycle and simple cycle. All the three GT systems have been analysed with wide range of parameters of pressure ratio, TIT, IAT and regenerator effectiveness etc. on GT system performance parameters, such as cycle efficiency, specific work output and specific fuel consumption. From the results of this study, the following conclusions are obtained:

- For wide range of parameters, the gas turbine (GT) with alternative regeneration system has superior cycle efficiency as compared to regenerative cycle or simple cycle.
- This alternative regeneration cycle is particularly attractive at high TITs as high as 1500 0C and above. The optimum pressure ratio of alternative regeneration cycle is only 22.5 whereas the same conditions, the optimum pressure ratio of conventional regeneration GT is 8.5 for TIT of 1500 0C.
- The specific fuel consumption of alternative regeneration system is lower as compared to regenerative cycle or simple cycle and the specific work output of alternative regeneration system can be improved by lowering the regenerator effectiveness which results in reduction in cycle efficiency.

- Even though the cycle efficiency of alternative regeneration system is superior to conventional regeneration or simple cycle, the impact of IAT on cycle efficiency is slightly higher in alternative regeneration as compared to conventional regeneration and simple cycle configurations for every 10 K temperature drop of inlet air temperature (IAT).
- For every 10 K temperature rise in inlet air temperature (IAT), the decrease in specific work output is relatively low in alternative regeneration as compared to conventional regeneration and simple cycle configurations.

**References**

[1] V. Ganesan, Gas Turbines by Tata Mc Graw Hill Publications

[2] Cohen et al., Gas Turbine theory by Pearson education Publications

[3] Y Cengel, Thermodynamics – An engineering approach by Mc Graw Hill Publications

[4] P. K. Nag, Power Plant Engineering by Tata Mc Graw Hill Publications

[5] Kousuke Nishida et al., Regenerative steam injection gas turbine systems – Applied Energy 81, 2005, 231-246

[6] H. Caniere et al., Raising cycle efficiency by intercooling in air cooled gas turbine - Applied Thermal Engineering 26, 2006, 1780-87

[7] De Lucia et al., Benefits of compressor inlet air cooling for gas turbine cogeneration plants, ASME Journal for Gas Turbine and Power, 1996, 118

[8] Khaliq et al., Thermodynamic performance evaluation of combustion gas turbine cogeneration system with reheat, Applied Thermal Engineering (24), 2004

[9] Y. S. Najjar, Enhancement of performance of gas turbine engines by inlet air cooling and co-generation system – Applied Thermal Engineering 16, 2(163-173), 1996

[10] Y. S. Najjar et al., Augmentation of gas turbine performance using air coolers – Applied Thermal Engineering (24) 2004, 415-429

[11] Kakaras et al., Compressor intake air cooling in gas turbine plants, Energy Journal of International (2004) 29 (12-15)

[12] E. Kakaras et al., Inlet air cooling methods for gas turbine based power plants – ASME Journal for Gas Turbine and Power, 2006, 128

[13] P. A. Dellenbeck, Improved gas turbine efficiency through alternative regenerative configuration, ASME Journal for Gas Turbine and Power, 2002, 124

[14] Sung Hoon Hwang et al., Design and off-Design characteristics of the Alternative Recuperated Gas Turbine Cycle with divided turbine expansion – ASME Journal for Gas Turbine and Power, 2007, 129

**Nomenclature**

f : fuel flow rate per unit air flow rate in kg of fuel/ kg of air

T1 : inlet air temperature in K

$\Delta p$  : pressure drop in bar

r : compressor pressure ratio

W : specific work in kW/kg/s

Cp : specific heat in kJ/kg/K

**Abbreviation**

ALT : alternative

CON : conventional

CV : calorific value of fuel in kJ/kg

GT : gas turbine

IAT : inlet air temperature in K

REG : regeneration

TIT : turbine inlet temperature in O C

sfc : specific fuel consumption

**Greek Symbols**

E : effectiveness of regenerator

$\eta$  : thermal efficiency of cycle

$\gamma$  : ratio of specific heat

**Subscripts**

a : ambient air

g : gas

c : compressor

cc : combustion chamber

HPT : high pressure turbine

PT : power turbine